



சர்தார் வல்லபாய் படேல் சர்வதேச ஜவுளி
மற்றும் மேலாண்மை கல்லூரி,
கோயமுத்தூர் – 641004.

सरदार वल्लभभाई पटेल इंटरनेशनल स्कूल ऑफ़
टेक्सटाइल्स एंड मैनेजमेंट
कोयंबटूर – 641004.

**SARDAR VALLABHBHAI PATEL INTERNATIONAL SCHOOL
OF TEXTILES AND MANAGEMENT,
COIMBATORE-641004.**

TENDER

**for Renovation of the girls' hostel by replacing the existing
Steel roof frame and sheets
with the reinforced concrete structure
without affecting the persisting wall-bearing structure**

TENDER

for Renovation of the girls' hostel by replacing the existing steel roof frame and sheets with the reinforced concrete structure without affecting the persisting wall-bearing structure

in

**SARDAR VALLABHBHAI PATEL INTERNATIONAL SCHOOL OF TEXTILES
AND MANAGEMENT, Coimbatore – 641 004**

Tender No : SVPISTM/CIVIL/GIRLS HOSTEL/2024-25/3
Tender Date : 14 – 04-2024
Name of the Work : Renovation of the girls' hostel by replacing the existing steel roof frame and sheets with the reinforced concrete structure without affecting the persisting wall-bearing structure

DETAILS OF ESTIMATED COST, COST OF TENDER DOCUMENT & EARNEST MONEY DEPOSIT OF THE TENDER:-

Approximate estimated cost of the tender (In Rs.)	Cost of Tender document (In Rs.)	EMD (In Rs.)
Rs. 15,50,000/-	Rs. 590/- (500 + 18% GST)	Rs. 31,000/-

GST NO : 33AAETS0003R1ZI
Pre-Bid Conference : 26.04.2024 at 11.00 A.M, Admin. Block,
SVPISTM, COIMBATORE – 641 004.
Last Date of submission : 06-05-2024 (2. 00 PM)
Address for submission of Tender : The Administrative Officer,
SARDAR VALLABHBHAI PATEL INTERNATIONAL
SCHOOL OF TEXTILES AND MANAGEMENT,
1483, AVANASHI ROAD,
Coimbatore – 641 004.
Date of Opening of Tender : 06–05-2024 (2.30 PM)
Cost of the application form : In the form of a Demand Draft
Earnest Money Deposit : In the form of Demand Draft/BG

Tenderer who are registered with NSIC/MSME authorities for the tendered service is exempted from the payment of EMD & Cost of the application form. (Proof to be attached)

NOTE: ALL THE PAGES SHOULD BE SIGNED BY THE TENDERER.

CONTENTS		
Sl. No.	DESCRIPTION	PAGE NO.
01	SECTION –1 TENDER NOTICE	3
02	SECTION – 2 TENDER SUBMISSION	4
03	TECHNICAL BID - QUALIFYING CRITERIA	5
04	EVALUATION CRITERIA & FINAL SELECTION	7
05	SECURITY DEPOSIT	7
06	AGREEMENT	8
07	SECTION 3: TERMS AND CONDITIONS	9
08	WORK FORCE POLICY	11
09	SECTION 4: MISCELLANEOUS	12
10	PENALTY CLAUSE	13
11	SPECIFICATION OF WORK	14
12	SECTION 6: APPLICATION PROCEDURE	16
13	APPLICATION FORM	18
14	DECLARATION FOR ACCEPTING TERMS & CONDITIONS	20
15	AUTHORISATION LETTER	24
16	BANK MANDATE	25
17	FINANCIAL – BID	27
18	Annexure 11 – Existing Structure of Building	28
19	Annexure 12 – Proposed Structure of the Building Plan	29



சா்தாரா வல்லபாய் பட்டல் சாவதேச ஜவுளி மற்றும் மேலாண்மை கல்லூரி
सरदार वल्लभभाई पटेल इंटरनेशनल स्कूल ऑफ टेक्स्टाइल्स एंड मैनेजमेंट
SARDAR VALLABHBHAI PATEL
International School of Textiles & Management
Autonomous Institute, Ministry of Textiles, Government of India.
#1483, Avanashi Road, Peelamedu, Coimbatore-641004. Tamil Nadu
Landline : 0422-2571675, 2592205 Fax: 0422-2571623 Web: www.svpistm.ac.in

No: SVPITM/CIVIL/GIRLS' HOSTEL/2024-25/3 dt. . @ Coimbatore the 14-04-2024.

SECTION 1 :

1) TENDER NOTICE

SARDAR VALLABHBHAI PATEL INTERNATIONAL SCHOOL OF TEXTILES AND MANAGEMENT, Coimbatore – 641 004 invites Tender in the prescribed format from the approved and eligible contractors/ reputed agencies having experience in construction work "for reinforced cement concrete without affecting the existing structure of the hostel and having adopting strong foundation by erecting concrete pillars and beams, as per specification required by SVPITM, Coimbatore".

2) BRIEF SCOPE OF WORK.

Replacing the existing steel roof frames and rooftop asbestos sheets with reinforced cement concrete without affecting the existing structure of the hostel and adopting a strong foundation by erecting concrete pillars and beams, as per specification and Drawings mentioned in Annexures 11 & 12 in the premises of SVPITM, Coimbatore – 641 004.

3) GENERAL INSTRUCTIONS:-

The tenderers should read carefully and understand all the conditions for the contract, schedule of quantities, drawings etc. attached with the tender document before actually quoting for the work. Any lapse may lead to:

- Rejection of the tender and/or
 - Forfeiture of your earnest money / and or
 - Recession / Termination of the contract and execution of balance work at the risk and cost of the defaulting contractor,
 - Debarring from future tenders.
- a) The intending tenderers shall note that the work is urgent and is to be positively completed within the stipulated period. Therefore, only those contractors who are confident and capable of carrying out the work within the stipulated period should apply for the work. The contractor who fails to commence and complete the work within the scheduled time shall be required to pay compensation as stipulated in para b,c,d, under Clause 5 of Section 4 of NIT.
- b) The time allowed for carrying out the work will be 45 days from the 5th day after the date of issue of the letter of award of work or from the first day of handing over of the site whichever is later.
- c) Applicants should have the minimum qualification criteria as per the technical bid Qualifying Criteria.

- d) Bidders should submit the non-refundable cost of the application form of Rs. 590/- and a refundable Earnest Money Deposit (EMD) of Rs. 31,000/- along with the Tender documents.
- e) A pre-bid conference will be held on 26-04-2024 at 11:00 Hrs. in the Institute to address any clarifications from prospective bidders and to facilitate dates for the site visit.
The last date of submission of tender is 06-05-2024 up to 2:00 PM.
- f) Interested firms/Agencies/Contractors meeting the qualification criteria are required to submit their tender in sealed envelopes. The envelope should be super-scribed as **"Tender document for Renovation of the girls' hostel by replacing the existing steel roof frame and sheets with the reinforced concrete structure without affecting the persisting wall-bearing structure in SVPISTM, Coimbatore – 641 004."**
Submitted by: (Name, Address, email, and Telephone number of the Bidder).
- g) The bidder should submit his detailed drawings (to scale) for the proposed structure based on the drawings of the SVPISTM.

SECTION: 2 TENDER SUBMISSION

1) OFFLINE SUBMISSION -- The bid should be submitted only in OFFLINE.

- a) The cover should contain all the prime eligibility documents along with fees towards the cost of the tender document, EMD, and all pages of the tender document with the signature of the tenderer and it should be **PVC / WAX sealed**.
- b) The envelope should be superscripted at the top of the cover as "Technical bid for Tender for the renovation of the girls' hostel by replacing the existing steel roof frame and sheets with the reinforced concrete structure without affecting the persisting wall-bearing structure.
- c) The Financial bid document should be removed from the tender document and covered with a separate sealed envelope with the name of the tenderer, superscripted at the top as 'Financial Bid for Renovation of the girls' hostel by replacing the existing steel roof frame and sheets with the reinforced concrete structure without affecting the persisting wall-bearing structure
- e) **The completed tender forms along with the enclosures and the sealed cover containing the financial bid should be submitted in ONE cover and addressed to**
Shri. S.U.SANKAR (Administrative officer)
SARDAR VALLABHBHAI PATEL INTERNATIONAL SCHOOL OF TEXTILES AND
MANAGEMENT, 1483, AVANSHI ROAD, COIMBATORE – 641004.
Contact Details (Mobile) : 9443432657
E-Mail Id : admin@svpitm.ac.in
- f) The sealed envelope should be submitted by Speed Post/Registered Post with acknowledgement due /courier (OR) in person at the reception of SARDAR VALLABHBHAI PATEL INTERNATIONAL SCHOOL OF TEXTILES AND MANAGEMENT, Coimbatore – 641 004 on or before the due date and time. **Any delay in postal transit will not be accepted as a valid reason for condoning the delay in the submission of the tender.**

- g) Technical Bids will be opened as per the schedule given on critical dates in the presence of bidders or their authorized representatives. If the opening date happens to be a closed day/holiday, the tender will be opened on the next working day. Only one authorised representative from the firm shall be allowed to participate in the opening of technical bids/price bids.

2) ACCEPTANCE AND REJECTION

SARDAR VALLABHBHAI PATEL INTERNATIONAL SCHOOL OF TEXTILES AND MANAGEMENT reserves the right to accept/reject any or all tenders and accept the whole or any part of the tender without assigning any reason. A tender that does not fulfil any of the terms and conditions of the tender or with incomplete documents in any respect will be rejected summarily.

3) EARNEST MONEY DEPOSIT

- a) The EMD as mentioned in the NIT should be paid and enclosed with the Bid documents.
- b) EMD shall be deposited in the form of a Demand Draft drawn in favour of SVPISTM, Coimbatore 641004" / BANK GUARANTEE in favour of "SVPISTM, Coimbatore-641004" issued by any Nationalized Bank valid for 210 days from the date of NIT.
- c) The DD/BG for the EMD amount in original should be attached to the Tender document.
- d) No other mode of payment for EMD will be accepted.
- e) **Tenderer who are registered with NSIC/MSME authorities for the tendered service/item is exempted from the payment of EMD on the production of a self-attested copy of the certificate issued by NSIC/MSME.**
- f) The EMD will not carry any interest while it is in the custody of SVPISTM.
- g) The EMD will be refunded to the successful/unsuccessful tenderers after the finalisation of the Tender. The EMD paid in the form of BG will be returned to the successful tenderer on payment of SD, execution of the agreement, and finalisation of the Tender.
- h) The EMD will be refunded to the unsuccessful tenderer after the finalisation of the Tender.
- i) The EMD will be forfeited if the successful tenderer does not commence the work within five days of the issue of the Work Order.
- j) The EMD will be forfeited if the tenderer withdraws the tender within the validity period of the bid.

4) TECHNICAL BID QUALIFYING CRITERIA

- a) The contractor should have a valid license/certificate to undertake construction work.
- b) A contractor should have an experience minimum of three years (2019-20, 2020 – 21, 2021-22, 2022-23, 2023-24) in the construction of Buildings in a Govt. sector/ PSUs/ Educational Institutions/ Private/ academic Institutions. (Attach Proof and Site photos along with technical bid)
- c) Should have an annual turnover of a minimum of Rs. 25 lakhs in similar Construction. (Please attach ITR/Relevant documents for the last three financial years). (I.e. 2020-21, 2021-22, 2022-23).
- d) Should have at least three (03) finished projects in a reputed organization/corporate house/educational institution.

- e) The Contractors should have a legal entity and provide the certificate, the Company having not ever been blacklisted by the Govt. or Non. Govt. Agencies.
- f) The contractor/Firm should have a valid Goods and Service Registration Number.
- g) The contractor/Firm should have a valid PAN Number.
- h) The bidder should not have been blacklisted or banned by any Govt. Department, PSU, University, Autonomous Institute, or any other Govt. Organization at any point of time and also no case of any nature i.e. CBI/ Civil//Income Tax/GST is contemplated or pending against them.

The final selection of the Contractor will be made based on various parameters (as fixed by the Committee/Competent Authorities) like visiting various existing sites of the Contractor, feedback from the previous clients of the bidder etc.

5) DOCUMENTS ESTABLISHING BIDDER'S ELIGIBILITY AND QUALIFICATIONS

The bidder shall furnish the self-attested copies of the following documents, as part of his bid documents establishing the bidder's eligibility. The original documents should be produced on demand for verification and return.

- a) Cost of Tender Document (Crossed DD in original) (Mandatory)
- b) Cost of EMD - DD/BG in original (Mandatory)
- c) Experience Certificate, Site-photos of the completed Building work in Govt. organisations / PSUs/Colleges/Schools/private for a minimum period of three years in any of the Financial Years i.e. 2019-20, 2020 – 21, 2021-22, 2022-23,2023-24.
- d) Details of all works of a similar nature completed in the last five years.
- e) Declaration for accepting terms and Conditions of SVPISTM.
- f) Certificate for not having near relatives working in SVPISTM.
- g) Copy of License/registration certificate for performing the work specified in this tender.
- h) Copy of PAN number.
- i) IT return copy for the assessment years (I.e. 2020-21, 2021-22, 2022-23).
- j) Latest profit and loss statement.
- k) Copies of Articles of Association and Memorandum of Association in case of Limited company OR Copies partnership Deed and Power of Attorney in case of Partnership Firm
- k) Affidavit in case of the sole proprietorship (in Non-Judicial Stamp Paper of Rs. 100.)**
- l) Copy of GST Registration Certificate.
- m) Self-declaration by the bidder stating that the Bidder **has not been black-listed** by any Central/ State Governments/ PSUs/Colleges/Schools in India at the time of submission of the bid must be submitted in this regard (Mandatory).
- n) Tenderer's Profile.

Any bid devoid of the above documents will be summarily rejected.

6) EVALUATION CRITERIA AND FINAL SELECTION

- 1) The committee constituted by the Director, SVPISTM, Coimbatore will examine the technical documents and decide the suitability as per the requirements of SVPISTM and the terms and conditions of the tender. Only the technical bids of the firms, which meet the qualification criteria, would be taken up for detailed evaluation.
- 2) Selection of the bidders shall be based on a weighted criteria system to be derived from the submitted tender documents, experience etc., In the case of non-fulfilment of minimum pre-qualification criteria of the technical bid, the bid of the respective bidder shall be rejected. The competent authority will decide regarding the selection of Contractors.

7) AWARD OF CONTRACT:-

- 1) The Contract will be awarded based on the rate quoted in the financial bid among the technically qualified bidders. Once the work order awarding the contract is sent to the Contractor, he must be ready to commence work in SARDAR VALLABHBHAI PATEL INTERNATIONAL SCHOOL OF TEXTILES AND MANAGEMENT, within 05 days of receiving the work order.
- 2) The competent Authority reserves the following rights :
 - a) to review the performance of the Contractor at the time of Construction and cancel the work order if the work is not as per the specifications, and drawings stipulated in the NIT.
 - b) to cancel the work order at any time without assigning any reason and the decision of the Director, SARDAR VALLABHBHAI PATEL INTERNATIONAL SCHOOL OF TEXTILES AND MANAGEMENT, Coimbatore – 641 004 will be final in awarding the contracts.

8) SECURITY DEPOSIT

- 1) The successful Bidder including NSIC/ MSME registered firms should remit a **Security Deposit equivalent to 10 % of the awarded amount** for the work specified for One year within five days from the date of receipt of the communication by the Bidder.
- 2) This security deposit is payable in the form of a Term Deposit Receipt (TDR) / Bank Guarantee issued by a Nationalised / Scheduled Bank and it should be for twelve months. Failure to pay the security deposit within the specified time will entail the forfeiture of EMD and also the rejection of the tender.
- 3) The Security Deposit will not carry any interest while it is in the custody of SVPISTM.
- 4) The Security deposit will be returned after the successful completion of the tender if there is no liability on the part of the Bidder to SVPISTM.
- 5) The Security deposit will be forfeited in the following circumstances.
 - a) In case any document is found false / forged at any stage, the Security deposit will be forfeited.
 - b) If the contract is terminated by the SVPISTM due to poor quality of service or negligence/misbehaviour / bad act of the contractor / his personnel or non-observing of the provisions stipulated in the contract, the Security deposit shall be forfeited.

- c) If the contractor is found violating any law/rule related to work and workman and a report in this regard is received from the competent authority indicating the contractor for violation of any law/rule, the security deposit shall be forfeited without prejudice to any other action as per provisions of the contract.
- d) If the contractor fails to undertake the work within the time limit mentioned, the penalty for delay shall be recovered from the Security deposit.
- e) If the contractor fails to rectify the defect in the work done as ordered by the SVPISTM or fails to make good the damage done to the assets of SVPISTM or state / central Govt. property or public property or other private operators' property while executing the work, the recovery to the extent of the cost of rectification or damage done as assessed by the SVPISTM, COIMBATORE shall be recovered from the pending bills / Security deposit.
- f) The assessment of recoveries made by the Director, SVPISTM Coimbatore shall be final and binding on the contractor.

9) AGREEMENT:

- a. The successful tenderer will be required to execute an agreement in a Non-judicial stamp paper of appropriate value within the time frame stipulated by SVPISTM, Coimbatore.
- b. The SVPISTM reserves the right to add/delete/modify the clauses in the agreement.
- c. Failure of the successful bidder to comply with this requirement shall constitute sufficient ground for the annulment of the award and forfeiture of the bid security (EMD) in which event the SVPISTM may make the award to any other bidder, at the discretion of SVPISTM or call for new bids.

10) PERIOD OF CONTRACT:

- a) The work should have been completed within 45 days from the date of commencement of work.
- b) Extension/non-extension will be the sole discretion of the authority and the Contractors cannot assume extension as their right.

11) TERMINATION OF CONTRACT:

- 1) The competent authority reserves the right to terminate the contract at any time without assigning any reason if it appears to the authority at any point of time that the services based on the quality of work
- 2) At any time during the period of the contract, if it comes to the notice of the SVPISTM that the contractor has misled this office by way of giving false/incorrect information which has been material in the award of the contract, the contract shall be liable to termination without any notice besides other legal action as per law. Further, in case of any breach, the contract can be terminated without any notice.

SECTION 3 TERMS & CONDITIONS.

1) GENERAL TERMS & CONDITIONS.

- a. **Tenderers are advised to inspect and examine the site and its surroundings and satisfy themselves before submitting the tender.**
- b. **The rates quoted shall be inclusive of all taxes (including GST), and all other charges such as Insurance, and transportation etc., Nothing extra shall be paid over the quoted rates.**
- c. It is the responsibility of the tenderer to check any correction or any modifications published subsequently in the website and the same shall be taken into account while submitting the tender.
- d. The Bidder submitting the tender would be deemed to have considered and accepted all the terms and conditions of the contract. No verbal or written enquiries will be entertained in respect of acceptance or rejection of the tender.
- e. The bidder having their close relatives working in SVPISTM, Coimbatore is not allowed to participate in the Tender, an affidavit confirming the same should be submitted in original to SVPISTM, Coimbatore.
- f. The contractor shall not sublease full or part of the contract. If found subleased, it leads to blacklisting of the vendor and penalization by the Institute. No Subletting of construction of work is permissible at any cost.
- g. The selected bidder will have to complete all the required formalities/obtain permits/licenses, if any, including agreement, etc. immediately within Five days after the award of the work order.
- h. Canvassing whether directly or indirectly, in connection with tenders, is strictly prohibited and the tenders, submitted by the contractors, who resort to canvassing, will be liable for rejection.

2) SPECIAL TERMS & CONDITIONS

- a) **The Contractor shall make his own arrangements for the electricity/water required for the construction work.**
- b) The contractor needs to use their machinery, tools, and vehicles for the transport of materials. Machinery which is brought by the contractors shall be their responsibility. SVPISTM shall not take any responsibility for materials and machinery brought by the contractor.
- c) The tenderer shall be responsible for arranging and maintaining at his own cost all materials, tools & plants, water, electricity, access facilities for workers and all other services required for executing the work.
- d) The contractor shall provide at his own cost suitable weighing and measuring arrangements at the site for checking the weight/dimensions as may be necessary for the execution of the work.
- e) All materials which are to be tested for use in work shall be procured well in advance so that enough time is available for testing and approval of these materials by the officer in charge.
- f) The water will be tested for its suitability for use in RCC work and nothing extra will be paid for on this account.

- g) No compensation/payment shall be payable to the contractor for any damage caused by rains, lightning, wind, or storm, during the execution of work. He will make good all such damages at his own cost and no claim on this account will be entertained
- h) The centering and shuttering required for RCC work will be brought to the site by the contractor well in advance so that the progress of work is not hampered due to the non-availability of the same. Nothing extra shall be paid for this.
- i) The contractor shall carry out at free of cost any damage caused to any structure/ property of SVPISTM / Govt. on account of the subject construction.
- j) The contractor is fully responsible for taking all possible safety precautions during preparation for and actual performance of the works, and for keeping the construction site in reasonable safe condition. The contractor shall protect all life and property from damage or losses resulting from his construction operations and shall minimise the disturbance and inconvenience to the public and the Institute.
- k) The contractor shall be solely liable for all expenses for and in respect of repairs and/or damage occasioned by injury of or damage to such underground and over-ground structures or other properties and undertake to indemnify and keep indemnified SVPISTM from and against all actions, cause of actions, damages, claims and demands what-so-ever either in law or in equity and all losses and damages and costs (inclusive between attorney and clients), charges and expenses in condition therewith and/or incidental thereto.
- l) If the completed work is not found satisfactory as per the prescribed specifications, corrective measures ordered by the officer-in-charge, SVPISTM shall be carried out immediately by the contractor without any additional expenditure liability to the SVPISTM.
- m) The contractor shall take instructions from the officer-in-charge for stacking materials in any place.
- n) Other agencies doing works related to this project will also simultaneously execute the works and the contractor shall afford necessary facilities for the same. The contractor shall leave such necessary holes, openings etc. for fan clamps, electric wiring etc. as may be required for other agencies.
- o) The contractor shall take all precautionary measures to avoid any damage to adjoining property. All necessary arrangements shall be made at his own cost.
- p) The contractor shall be responsible for the watch and ward/guard of the work, and safety of all fittings and fixtures including sanitary and water supply fittings and fixtures provided by him against pilferage and breakage till the work is physically handed over to the Institute.
- q) The work is to be carried out in the SVPISTM premises, where free movement of the contractor's vehicle and labour may be restricted. The contractor has to follow the security requirements of SVPISTM in the campus area.
- r) Samples including brand/quality of materials and fittings to be used in the work shall be approved by the Officer-in-Charge, well in advance of actual execution.
- s) Existing drains, pipes, cables, overhead wires, sewer lines, water lines and similar services encountered in the course of the execution of work shall be protected against damage by the contractor at his own expense.
- t) The contractor shall comply with proper and legal orders and directions of the local or public authority or municipality abide by their rules and regulations and pay all fees for which he may be liable and nothing extra shall be payable on this account. The work shall be carried out without infringing on any of the local Municipal Bye-Laws.
- u) The dismantled material which can be reusable shall be kept at the designated place provided by SVPISTM.

- v) The contractor shall clear the site thoroughly of all scaffoldings, materials rubbish etc. left out of his work and dress the site around the building to the satisfaction of SVPISTM before the work is considered as complete.

3) WORKFORCE POLICY

- a) The Contractor has the responsibility to bring the workforce to complete the work as per the requirements of SVPISTM.
- b) Employment of child labour defined as per relevant laws is strictly prohibited.
- c) The Contractor shall be responsible for the proper conduct and behavior of the employees engaged. In case, the workforce employed by the Successful Tenderer commits any act of omission/Commission that amounts to misconduct/indiscipline/incompetence, the tenderer will be liable to take appropriate disciplinary action against such persons, including their removal from the site of the work, if required by Director, SVPSITM.
- d) The Contractor will be fully responsible for any accident or mishaps involving building workers engaged and the contractor will pay claims made by the victims. The contractor shall be liable to pay compensation for any loss and damages caused to the property of the Institution or its workers.
- e) The SVPISTM, Coimbatore premise is a '**NO SMOKING & TOBACCO FREE ZONE**', any personnel deployed by the agency in the Institute found smoking, eating pan/gutka or intoxicants/drugs, etc. shall be punished as per the law of land/rules of the Institute.
- f) The safety of workers /personnel engaged by the contractor is the sole responsibility of the contractor.
- g) The contractor should ensure that all workers engaged by them are adequately trained for the use of construction equipment/firefighting maintained in the campus, and use of FIRST AID KIT maintained in the campus in case of requirement.
- h) The contractor should ensure that all personnel engaged by them are Polite and possess good manners while on duty. No damage shall happen to the Institute's property, equipment, and systems and if anything happens by the action of the contractor or his personnel during the period, the contractor is required to set right/repair or make good the loss according to the decision taken by the Institute.
- i) All liabilities arising out of accident or death while on duty shall be borne by the Contractor
- j) The Institute shall not provide accommodation to any workers of the agency.
- k) If any demolishing or dismantling at the time of construction the materials are to be removed properly by the contractor.
- l) The institution shall not take any responsibility for accommodation and food facilities for Workers or contractors.
- m) On the occurrence of any accident, as defined under the guidelines for settlement of a claim for Compensation on accident, they will be paid by the contractor.
- n) The workers employed by the contractor shall not claim any benefit, compensation, absorption, or regularization of their services in the establishment of SVPISTM either under the provision of the Industrial Disputes Act 1947 or the Contract Labour (Regulation & Abolition) Act 1970.

4) CONDITIONS ON QUALITY TO BE PROVIDED BY THE CONTRACTOR

- a) The contractor shall use standard materials as specified for construction work.
- b) The materials brought to the site shall be inspected by the authorized person of this Institute and certified before being brought into use.
- c) SVPISTM reserves the right to make any change, omission, additions (or) alterations to the original design, Drawings, or specifications.
- d) In case of any modifications, the instructions shall be obtained from SVPISTM in writing.
- e) Such changes, omissions, and substitutions shall be deemed to have been formed as work included in the original tender and the contractor shall be bound to carry out the work.
- f) If any work is found to have been executed by the contractor with unsound, imperfect (or) unskillful workmanship (or) with inferior materials or it is not as per the contract, the contract shall make good the defective work at his own expense and remove the materials or articles complained in writing by the Officer-in-charge.
- g) The contractor shall be responsible for any damage (or) any defects noticed within three days. The work shall as soon as practicable after the expiration of the maintenance period be handed over to the Engineer/officer-in-charge in good and perfect condition.

5) WORKING TIME

- a) The contractor can commence the work at 8.00 AM daily and close by 6.00 PM. None of the contractor's representatives/ workers will be permitted to stay in the working place beyond normal working hours. In cases where the work has to be carried out beyond normal working hours/holidays/Sundays prior permission shall be obtained in writing from the competent authority.
- b) The construction work shall be carried out in the presence of an authorised person of SVPISTM.

SECTION: 4 MISCELLANEOUS

1) Arbitration:

All disputes or differences whatsoever between the contractor and the Institute related to the Contract will be settled by arbitration as per the provisions of the Indian Arbitration and Conciliation Act, 1996 and shall be binding for all purposes.

2) Legal dispute:

Any disputes or differences whatsoever arising out of or relating to the construction, interpretation, operation or effect of any of the terms in this agreement or the breach thereof and claims and benefits which arise out of the subject work but which are disputed, shall be settled by Courts of Law having jurisdiction in Coimbatore only.

3) Inspection authority:

An authorized representative(s) of the Institute will carry- out periodic inspections and surprise checks to ensure the quality of material and site condition.

4) FORCE MAJEURE

- a) If at any time, during the continuance of this contract, the performance in whole or in part, by either party of any obligation under this contract shall be prevented or delayed by reasons beyond control -FORCE MAJEURE- Neither party shall, by reasons of such events be entitled to terminate this contract, nor shall either parties have any claim for damages against the other in respect of such non-performance or delay in performance.

- b) The force majeure shall include war or hostility, acts of the public enemy, civil commotion, sabotage, fire, floods, explosions, epidemics, quarantine, restrictions, strikes, or lockouts, or acts of God (hereinafter referred to as eventuality).
- c) Provided such force majeure provisions apply only if notice of happening of any such eventuality is given by either party claiming concession to the other within 21 days from the date of occurrence thereof,
- d) Provided activities under the contract that were interrupted under the force majeure event are resumed as soon as practicable after such event comes to an end, or ceases to exist, and the decision of the SVPISTM, Coimbatore as to whether the activities have been so resumed or not, shall be final and conclusive.
- e) Provided further that if the performance in whole or part of, any obligation under this contract is prevented or delayed by reasons, for any such events for a period exceeding 60 days, either party may at his option terminate the contract.

5) PENALTY CLAUSES

Failure to construct in terms of quality, quantity, and as per the requirements will attract a penalty. For not adhering to contractual conditions, SVPISTM shall be free to impose a monetary fine as deemed fit on the Contractor. Fines imposed shall be remitted by the contractor to the Institute account or else the same shall be adjusted from the Security Deposit.

- a) If any consequential damages occur while carrying out the work, the damage incurred so should be borne by the tenderer. Quantum of liquidity damages assessed by the SVPISTM shall be final and non-challengeable by the contractor.
- b) **PENALTY FOR DELAY IN COMMENCEMENT OF WORK:** Work has to be commenced as per the schedule. For the delayed commencement of work, a delay of every week or part thereof, an amount equivalent to 0.5 % subject to a maximum of 12% of the contractor's claim made for the execution will be deducted from the amount payable in the settlement of the claim at the discretion of the Director.
- c) **PENALTY FOR DELAY IN COMPLETION OF WORK:** Work has to be completed as per the schedule. For the delayed completion of work, a delay of every week or part thereof, an amount equivalent to 0.5% subject to a maximum of 12% of the contractor's claim made for the execution will be deducted from the amount payable in the settlement of the claim at the discretion of the Director.
- d) The Director, SVPISTM shall be the Competent Authority regarding the imposition of penalty and quantum of the penalty and her decision shall be final.

6) BRAND OF SOME OF THE MATERIALS TO BE USED FOR THE CONSTRUCTION is ISI APPROVED PRODUCTS:-

Cement – Ultratech /Ambuja /ACC for all purposes
Steel – TATA/JSW/Agni /Steel authority of India for all sizes
Bricks – Burnt clay bricks of standard sizes from Approved companies
Sand – M - Sand for construction & P – Sand for Plastering
Gravel – 20mm for all purposes
Paints – Asian/ Nippon

Note: -

- a. Certification for the cement of IS 12269: 1987 for 53-grade ordinary Portland cement (OPC) should need to be used.
- b. Certification for the steel of IS 1786: 2008 for Fe 550 grade steels should need to be used.
- c. Certification for M – Sand & gravel of IS 383: 1970 for construction should need to be used.
- d. **Reinforced Cement Concrete (RCC) of M20 grade (1:1.5:3) of 5-inch thickness is poured and compacted using Ready Mix Concrete (Branded Cement)**

7) DRAWINGS, SPECIFICATION AND TIME SCHEDULE

(i) The Drawings for the existing structure of the building & proposed work are enclosed as Annexures 10 & 11

(ii) Detailed Scope and Specification of Work. :-

- 1) Dismantling carefully, the already existing steel roof frames and rooftop sheets without damaging the structure.
- 2) The earthwork has to be excavated for the footings wherever necessary as per the drawings and the pillars (columns) are to be erected and concreted till grade beam bottom level. (Backfilling and levelling as per recommendations have to be done)
- 3) Footing details – Single mat reinforcement with 10mm TMT bars for the main rod and 8mm for the distribution rod. (all footings)
- 4) Columns, Grade beam (Plinth beam) and Roof beam details should be followed as mentioned in the drawing.
- 5) Roof slab details – One-way slab with L/3 crank and 10mm TMT bars for main rod and 8 mm for distribution rod. (Provide extra rod if necessary)

6) Roof concrete (slab concrete) should be poured with RMC (Ready Mix Concrete) only. (any other mode will not be accepted)

7) Reinforced Cement Concrete (RCC) of M20 grade (1:1.5:3) of 5-inch thickness is poured and compacted using a vibrator machine. (curing of concrete for a minimum of 21 days compulsory)

8) All columns (Pillars) are to be raised by 2 feet from the roof concrete

9) Parapet wall to be constructed up to 2 feet height all over the outline of the roof concrete.

10) Terrace floor, flooring surface to be finished by laying cooling tiles (roofing tiles) with a proper slope for rainwater drain.

11) Patchwork is to be done in places of connection of the already existing structure and the new one wherever applicable.

12) Plastering the inner wall and outer wall with P-sand and proper curing is required.

13) After all structural and finishing works complete, painting works are to be carried out with emulsion finishing is required for both sides (Inner and Outer)

(iii) TIME SCHEDULE FOR COMPLETION OF WORK

Sl. No	Description of work	No of Days
01	Dismantling of existing steel roof frames and rooftop sheets.	03
02	Earthwork – excavation of soil for footing	02
03	Erection of pillars from concreting, backfilling of soil and levelling.	05
04	Grade beam – Concreting work	03
05	Concreting of Pillars up to the lintel	05
06	Lintel concreting	03
07	Concreting of Pillars from Lintel to Roof level	03
08	Roof concreting	05
09	Curing, plastering, Parapet wall, terrace flooring and completion of work	16

SECTION: 5

1. PAYMENT OF BILLS

- a) The bills are paid only as per schedule.
- b) The contractor shall submit the bills only in printed form
- c) The bills for payment should be prepared neatly & signed.
- d) The bill of work shall be prepared as per the rates specified in the tender.
- e) The approved contractor should note the tender number in the concerned bills for payment.
- f) The claim shall be inclusive of all taxes.
- g) The dues to the institute will be recovered from the bills
- h) The payments will be released as per the stages of construction which will be checked and signed by the nominated person of SVPISTM, Coimbatore.

Payment per stage of work	Percentage
On completion of the foundation & erection of concrete pillars	20
On completion of grade beam and erection of pillars till roof level	20
On completion of centering and RCC work (roof concrete)	30
On completion of parapet wall & Laying roof tiles	10
On completion of all works including Painting work	10
Total	90

- i) The Payment shall be released only after completion of the work and certification in the respective work stage by the authorised person of SVPISTM.
- j) The balance of 10% of the payment will be released only on successful completion of the work in all the stages and the management certificate issued.

SECTION: 6

1) APPLICATION PROCEDURE

- a) The tender is to be downloaded from the website and print is to be taken on A4 size paper and details are to be entered by the tenderer at the various locations in the document. It shall be ensured that the document is printed as appearing in this bid document, there is no change in formatting, no. of pages etc. and all pages are legible and clear.
- b) Submission of Xerox or photocopy of the tender document is prohibited.
- c) Correction fluid should not be used in rates quoted in tender documents. In case the use of correction fluid is noticed, such tender will be liable for rejection.
- a) If an individual makes the application, it shall be signed by the proprietor above his full typewritten name and current address.
- b) If the application is made by a proprietary firm, it shall be signed by the proprietor above his full typewritten name and the full name of his firm with its current address.
- c) If the application is made by a firm in partnership, it shall be signed by all the partners of the firm above their full typewritten names and current address, or by a partner holding power of attorney for the firm or any person authorized by all the partners. In such a case, a certified copy of the power of attorney shall accompany the application. A certified copy of the partnership deed and the current address of all the partners of the firm shall also accompany the application.
- d) If the application is made by a limited company or a corporation, it shall be signed by a duly authorized person holding power of attorney for signing the application. In such a case, a certified copy of the power of attorney shall accompany the application. Such a limited company or corporation may be required to furnish satisfactory evidence of its existence before the pre-qualification application is filed.

ANNEXURE - 1

APPLICATION

From

To
The Director,
SARDAR VALLABHBHAI PATEL INTERNATIONAL SCHOOL
OF TEXTILES AND MANAGEMENT,
Coimbatore-641 004.

Madam,

SUB: Submission of tender application for participating in tender floated for the renovation of the girls' hostel by replacing the existing steel roof frame and sheets with the reinforced concrete structure without affecting the persisting wall-bearing structure in SVPISTM – Coimbatore -- reg.

Having examined the details given in the Tender Document SVPISTM/CIVIL/GIRLS HOSTEL/2024-25/3 dt. @ Coimbatore the 14-04-2024, for the renovation of the girls' hostel by replacing the existing steel roof frame and sheets with the reinforced concrete structure without affecting the persisting wall-bearing structure in SVPISTM **decided** by the Institute, and published in the Institute website, we hereby submit the pre-qualification documents. We hereby certify that all the statements made and information supplied in the enclosed forms and accompanying statements are true and correct. We have furnished all information and details necessary for pre-qualification and have no further pertinent information to supply.

We undertake that, if any information or document is found to be false or forged, my Application/ empanelment is liable to be rejected/cancelled by SVPISTM, Coimbatore at any point of time.

I/We agree that should I/We fail to commence the work specified in the above memorandum, an amount equal to the amount of the earnest money mentioned in the form of invitation of the tender shall be forfeited to the SVPISTM and the same may at the option of the competent authority on behalf of SVPISTM be recovered without prejudice to any right or remedy available in law out of the deposit in so far as the same may extend in terms of the said bond and in the event of deficiency out of any other money due to me/us under this contract or otherwise.

I/We have read and examined the notice inviting tender, Drawings & Design, General Rules and Directions, Conditions of Contract, Clauses of Contract, Special conditions, Schedule of Rate & other documents and Rules referred to in the Conditions of Contract and all other contents in the tender document for the work. I/We hereby tender for the execution of the work specified for the SVPISTM within the time specified in the schedule, schedule of quantities and in accordance in all respects with the specifications, designs, drawings and instructions,

Date of submission:

Signature of Applicant
Name of the Organization (Company seal)

APPLICATION FORM

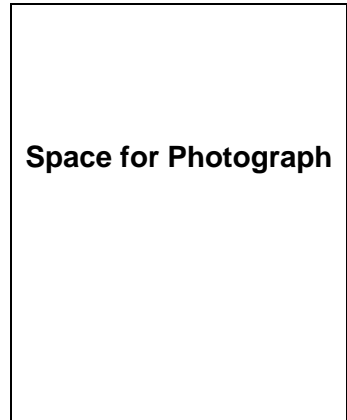

1) Name of the Tenderer /Agency/Company :

2) Name of the tenderer submitting the tender
(Signing the tender) whose photograph is affixed :
(In the case of Proprietary/partnership firms, the
the tender has to be signed only by the Proprietor/
Partner, as the case may be)

3) Address of the Tenderer/Firm/Company :

4) Communication Postal Address

5) Phone No / Mobile No. :

6) E-Mail ID :

7) Registration & Incorporation particulars of
the Proprietorship/Agency/firm/Company,
(if any)

Proprietorship. :

Partnership. :

Private Limited. :

Public Limited. :

(Please attach copies of documents)

8) Name of the Proprietor/ Partners/ Directors :

9) Name of Tenderers bank, address, and the :
Current account number, having ECS/EFT facility :

10) Permanent Income Tax Number, Income Tax circle:

11) GST Registration No: :

12) Details of the supervisory staff :

CERTIFICATE

I/we, S/o..... do hereby declare that the details given in the tender document are true and correct. In the case at any stage, it is found that the information given by me is false/ incorrect, SVPISTM shall have the absolute right to take any action as deemed fit/without any prior intimation to me.

Place:

Date:

Signature of Tenderer/Authorized Signatory

Name of the Tenderer:

Seal of the Tenderer :

Address :

ANNEXURE – 3

DECLARATION FOR ACCEPTING AND TERMS ND CONDITIONS.

From

To
The Director,
SARDAR VALLABHBHAI PATEL INTERNATIONAL SCHOOL OF TEXTILES
AND MANAGEMENT,
Coimbatore- 641 004.

Madam,

We are willing to undertake the work of replacing the existing asbestos sheets with reinforced cement concrete without affecting the existing structure of the Girls' hostel by erecting concrete pillars as per the terms and conditions of the tender floated vide Tender No. SVPISTM/ /CIVIL/GIRLS HOSTEL/2024-25/3 dt. @ Coimbatore the 14-04-2024. We hereby agree to abide by all the terms and conditions mentioned in the tender document.

Further, we hereby undertake that there are pages, serially numbered, in the tender including supporting documents.

Signature
Date:
Place:
Seal :

ANNEXURE – 4

DECLARATION

From

M/s. _____

To

**The Director,
Sardar Vallabhbhai Patel International School of Textiles and Management,
Coimbatore– 641 004.**

I, _____ Son/Daughter/Wife of Shri. _____
the proprietor/Director/ authorized signatory of the agency/Firm mentioned above is competent
to sign this declaration and execute this Tender document.

I/we have carefully read and understood all the terms and conditions of the tender and
undertake to abide by them.

The information/documents furnished along with the above application are authentic to the best
of my knowledge and belief. I/we, am/are well aware of the fact that furnishing any false
information/ fabricated document would lead to rejection of my tender at any stage besides
liabilities towards prosecution under appropriate law.

I/We further undertake that none of the Proprietor/Partners/Directors of the Agency/agency was
or is the Proprietor or Partner or Director of any Agency with whom the Government has banned
/suspended business dealings. I/We further undertake to report to the Director, SVPISTM,
Coimbatore immediately after we are informed but in any case not later than 15 days, if any
Agency in which Proprietor/Partners/Directors are Proprietor or Partner or Director of such an
Agency which is banned/suspended in future during the currency of the Contract with you.

Yours faithfully,

Signature of the bidder
Name:
Designation:

Date:
Place:
Name:
Designation:
Seal of the Agency:
Address:

ANNEXURE - 5

CERTIFICATE ON NON-PARTICIPATION OF NEAR RELATIVES IN THE TENDER

I _____ S/O _____

Participating in the Tender for the construction services to SVPISTM, Coimbatore 641 004I at the mentioned rate do hereby certify that none of my relative(s) is/are employed in the SVPISTM unit as per details given in the tender document. In the case at any stage, it is found that the information given by me is false/incorrect, SVPISTM shall have the absolute right to take any action as deemed fit without any prior intimation to me.

Signature of the tenderer)

Name (Block Letters):

Position: Date:

Note: In the case of a proprietorship firm the certificate will be given by the proprietor, for a partnership firm, the certificate will be given by all the Partners, and in the case of the limited company by all the Directors of the company.

ANNEXURE - 6

CERTIFICATE & DECLARATION

It has been certified that all information provided in the tender form is true and correct to the best of my knowledge and belief. No forged/tampered document(s) are produced with the tender form for gaining an unlawful advantage. I/We understand that SVPISTM, Coimbatore is authorized to enquire to establish the facts claimed and obtain confidential reports from clients.

In case it is established that any information provided by me/us is false/misleading or in the circumstances where it is found that we have made any wrong claims, we are liable for forfeiture of EMD/SD and or any penal action and other damages including withdrawal of all work/purchase orders being executed by us. Further, SVPISTM Coimbatore is also authorized to blacklist our firm/company/agency and debar us from participating in any tender/bid in the future.

I / We assure the Institute that neither I / We nor any of my / our workers will do any act/s which are improper/illegal during the execution in case the tender is awarded to us. Neither I / We nor anybody on my / our behalf will indulge in any corrupt activities/practices in my / our dealing with the Institute.

Our Firm/ Company/ Agency is not been blacklisted or banned by any Govt. Department, PSU, University, Autonomous Institute, or any other Govt. Organisation and also no case of any nature i.e. CBI/ Civil//Income Tax/GST/EPF/ESIC is contemplated or pending against us.

Date :
Place :

Signature of the Tenderer
Stamp

Annexure - 7

AUTHORISATION LETTER

To

**The Director,
SVPISTM,
COIMBATORE - 641004.**

Sir/Madam,

Subject - Authorization for attending bid opening on 06-05-2024 for the
Tender for construction work – reg.

Order of Preference	Name	Specimen Signature
1.		
2.		
3.		

Signature of the Tenderer

Note:

Only one representative will be permitted to attend the bid opening. An alternative representative will be permitted when the regular representative is not able to attend. The person who is authorized to attend the bid opening must have the authorization certificate. Permission for entry to the hall where bids are to be opened may be refused in case authorization as prescribed above is not mentioned.

Annexure - 8

MANDATE FORM

**ELECTRONIC CLEARING SERVICE (CREDIT CLEARING)/REAL TIME GROSS SETTLEMENT (RTGS)
FACILITY FOR RECEIVING PAYMENTS**

DETAILS OF ACCOUNT HOLDER:-

NAME OF THE ACCOUNT HOLDER	
COMPLETE CONTACT ADDRESS	
TELEPHONE NUMBER//E-MAIL	

BANK ACCOUNT DETAILS:

BANK NAME	
BRANCH NAME WITH COMPLETE ADDRESS	
TELEPHONE NUMBER AND E-MAIL	Ph. No : Bank E-mail :
WHETHER THE BRANCH IS COMPUTERISED	YES / NO
WHETHER THE BRANCH IS RTGS ENABLED. IF YES, THEN WHAT IS THE BRANCH'S IFSC CODE	YES / NO IFSC -
IS THE BRANCH ALSO NEFT ENABLED	YES / NO
TYPE OF BANK ACCOUNT (SB/CURRENT)	SAVINGS ACCOUNT / CURRENT ACCOUNT
BANK ACCOUNT NUMBER	
MICR CODE OF THE BANK	

Annexure - 9

CHECKLIST

Sl. No	Document / Form	Remarks
1	Tender form in original, duly filled in and signed by the Bidder on each page. (Mandatory)	
2	DDs for the cost of the Tender Form (Mandatory)	
3	Cost of EMD DD/ Bank Guarantee (Mandatory)	
4	Experience photos in the field of Construction of Building services in Govt. organizations / PSUs/Colleges/Schools for a minimum period of two years in any of the Financial Years ie. 2020-2021, 2021-22 2022-23, 2023-24 (Mandatory)	
5	Certificate for not having near relatives working in SVPISTM	
6	Details of all works of a similar nature completed in the last five years.	
7	PAN number –proof copy to be enclosed	
8	GST number (Proof of application registration if number not provided)	
9	IT return copy for the assessment years 2021-22, 2022-23 & 2023-24	
10	Latest profit and loss statement.	
11	Copy of License/Certificate) for carrying out the specified work. (Valid on the date of tender Opening	
12	All Declaration & Certificates in NIT (Mandatory)	
13	E-payment mandate form	
14	Copy of the Article & Memorandum of Association of the company in case of Limited company OR Copies of partnership Deed and Power of Attorney in case of Partnership Firm OR Affidavit in case of the sole proprietorship.	
15	Self-declaration by the bidder stating that the Bidder has not been black-listed by any Central/ State Governments/ PSUs/Colleges/Schools in India at the time of submission of the bid must be submitted in this regard (Mandatory).	

FINANCIAL BID

(for Renovation of the girls' hostel by replacing the existing steel roof frame and sheets with reinforced concrete as per drawings & Specification)

Total cost for work (in figures)	Rs. _____ (including Tax)
--	--

In Words

(Rs. _____)
(including Tax) only.

Signature of Tenderer/Authorized Signatory :
Name of the Tenderer :
Seal of the Tenderer :
Address :

Note: -

(if there is any discrepancy in figures and words in the quote, the rate quoted in words shall prevail)

EXISTING
B.Sc GIRLS HOSTEL BLOCK
GROUND FLOOR

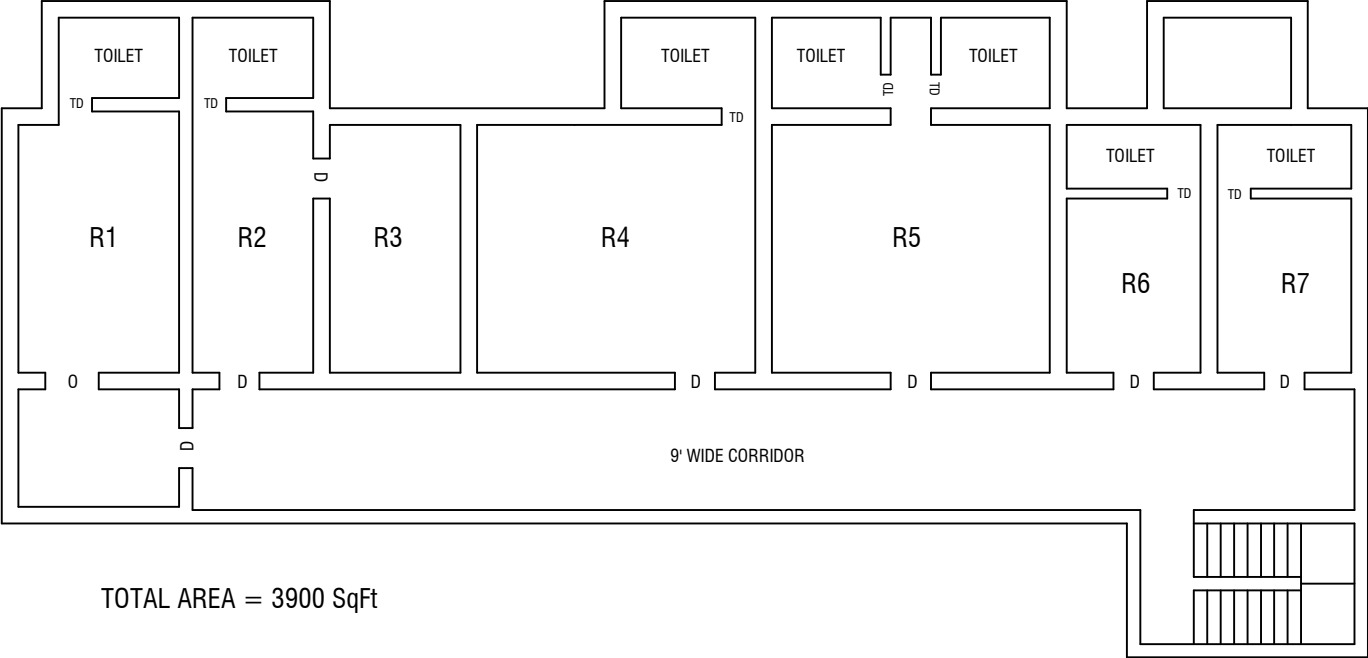
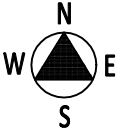

EXISTING
B.Sc GIRLS HOSTEL BLOCK
TERRACE FLOOR

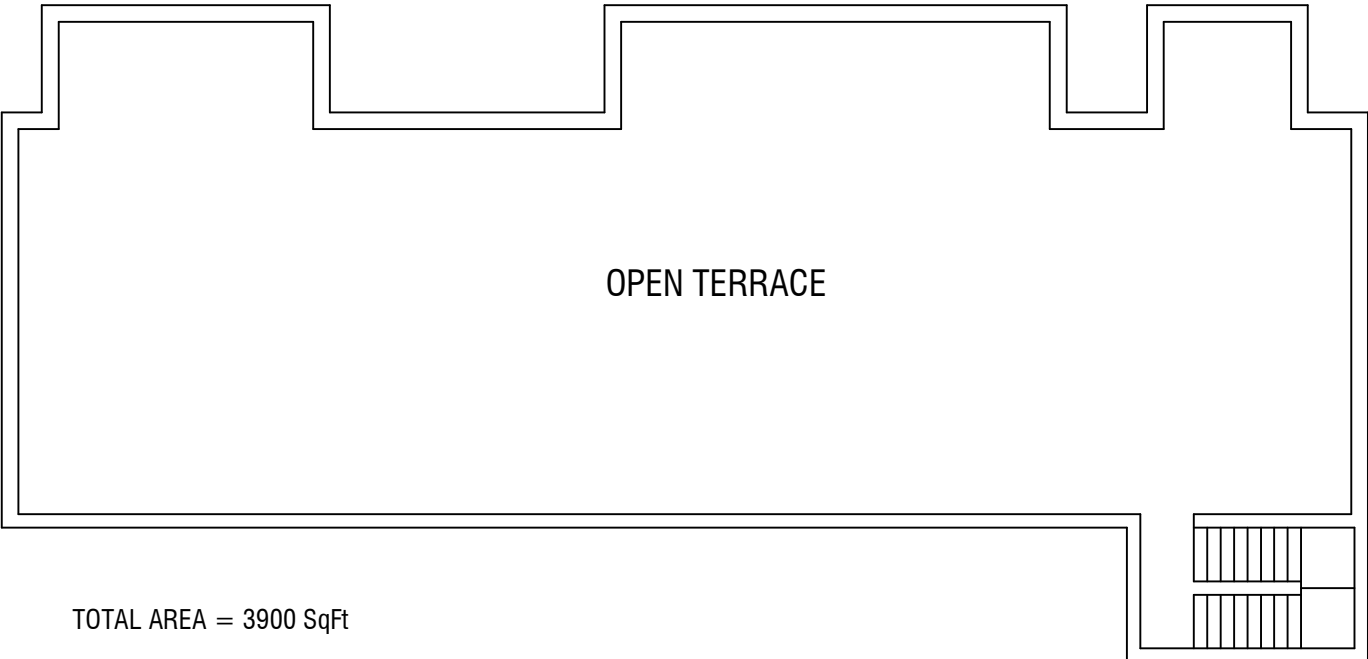
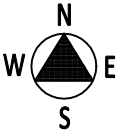

PROPOSED B.Sc GIRLS HOSTEL BLOCK STRUCTURAL DETAILS

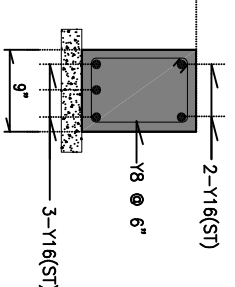
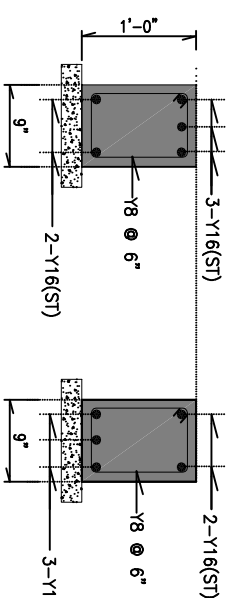
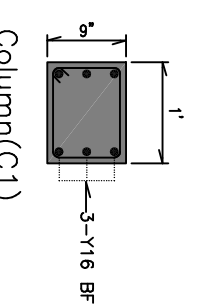
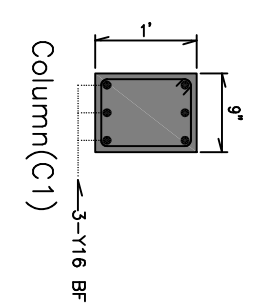
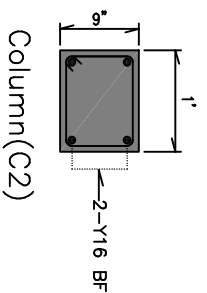
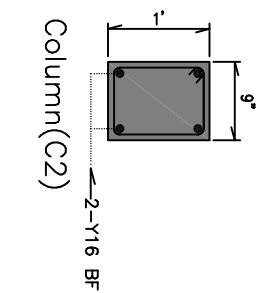
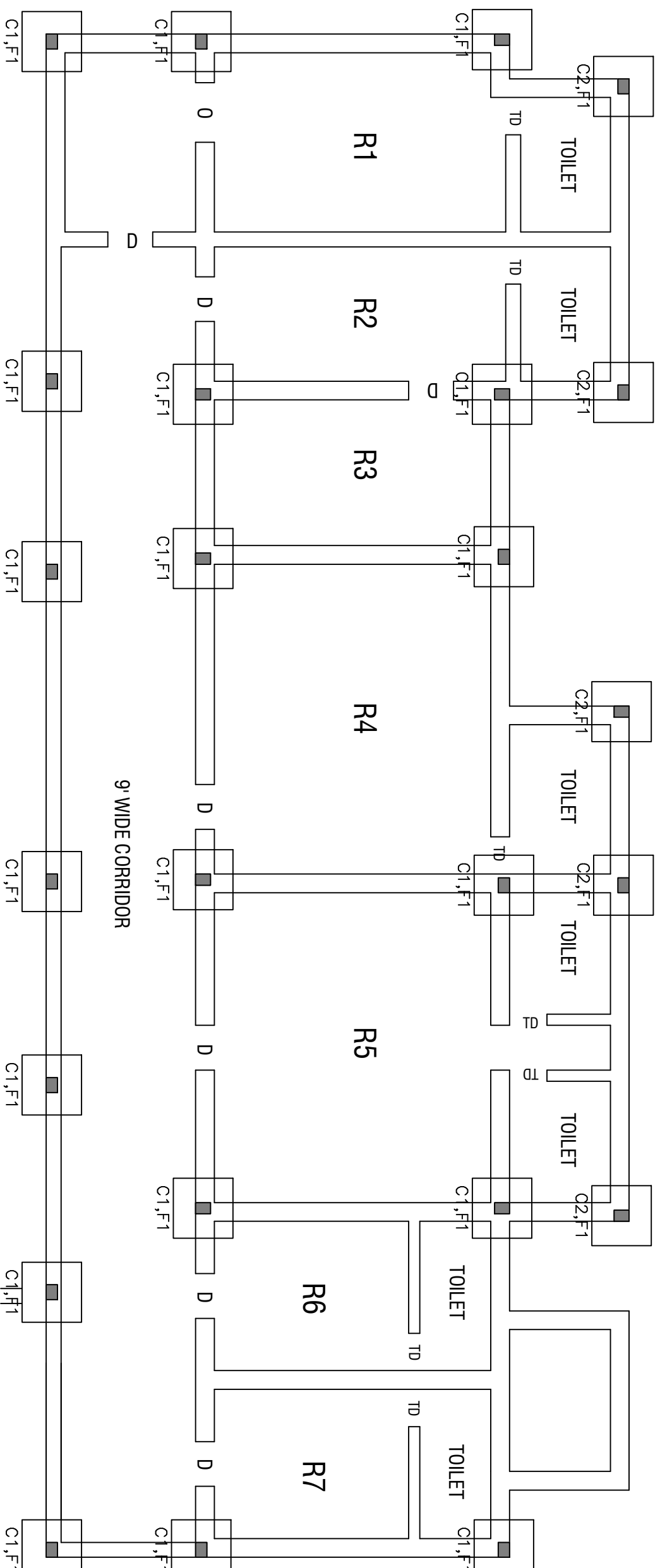
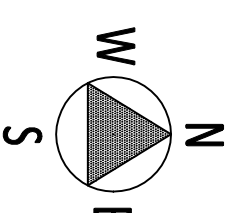

ROOF BEAM
(9' x 1'-0")

Footing to Plinth lvl = 6'
Roof Height = 10'

PARAPET WALL TO BE RAISED BY 2' HEIGHT (overall)